

■ Features:

- Part No:A1255H
 - Poles: 02 ~ 16
 - Material: Nylon 66 UL 94V-0
 - Rated Voltage:250V AC,DC
 - Rated Current:1A AC, DC
 - Withstanding Voltage:800V AC/minute
 - Contact Resistance:20M Ω (Max)
 - Insulation Resistance:1000M Ω (Min)
 - Temperature Range:-25° C~+85° C
- 5PIN及5PIN以下为单卡点, 5P以上为双卡点, 4PIN有单双卡点。

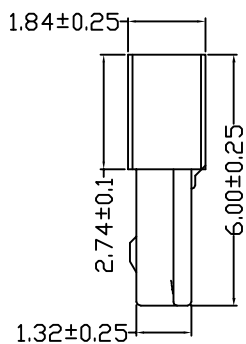
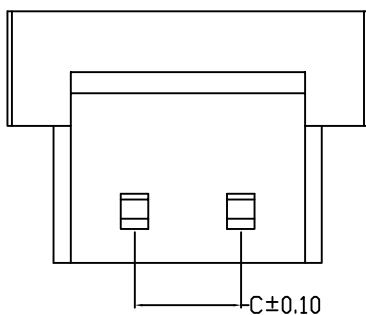
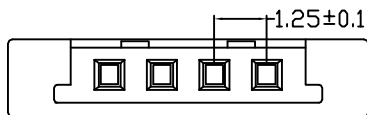
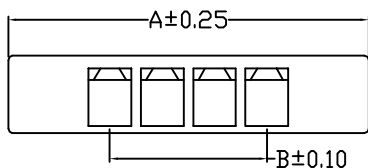

PART NO.	Dimensions			Pcs/Bag
	A	B	C	
02P	6.10	1.25	-	1000
03P	7.35	2.50	-	1000
04P	8.60	3.75	2.54	1000
05P	9.85	5.00	3.79	1000
06P	11.10	6.25	5.04	1000
07P	12.35	7.50	6.29	1000
08P	13.60	8.75	7.54	1000
09P	14.85	10.00	8.79	1000
10P	16.10	11.25	10.04	1000
11P	17.35	12.50	11.29	1000
12P	18.60	13.75	12.54	1000
13P	19.85	15.00	13.79	1000
14P	21.10	16.25	15.04	1000
15P	22.35	17.50	16.29	1000
16P	23.60	18.75	17.54	1000

东莞市连海电子有限公司
DONG GUAN LIAN HAI ELECTRONICS CO.LTD

核准	单位	比例	材质	颜色
周涛	M M	1:1	PA6694V0	*
审核	版次	图法	未标注公差:	

料号	JAE1.25单排-HSG	A0		.0 ± 0.30 .00 ± 0.20 .000 ± 0.10
品名	1.25mm pitch wire to board connector	绘图	页码	
图号		2013/10/05	1/1	

■ Features:

- Part No:A1255T
- Used in A1255H、A1256H series socket

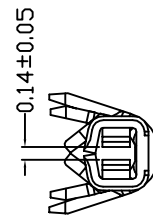
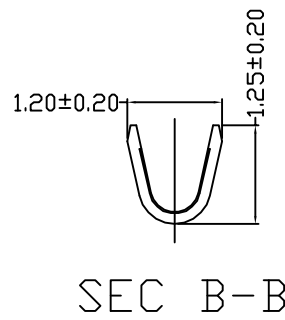
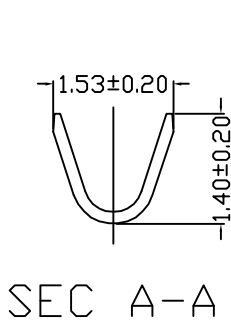
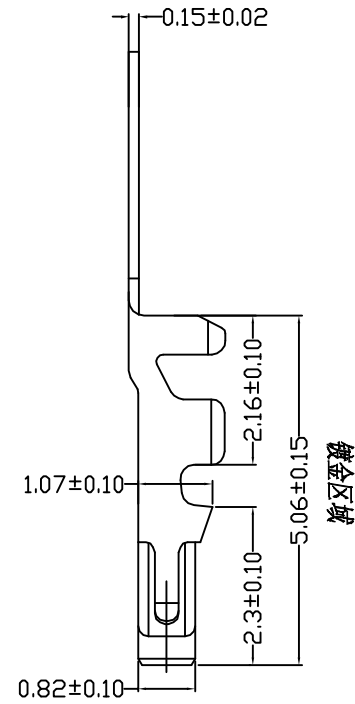
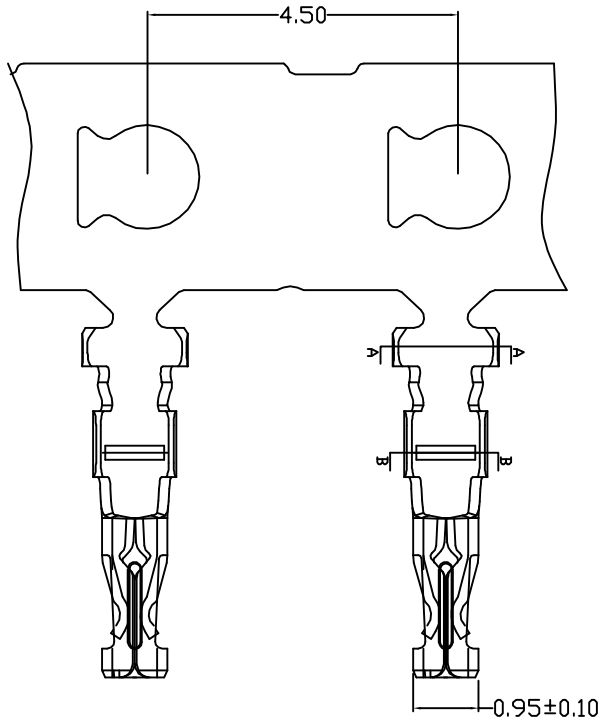
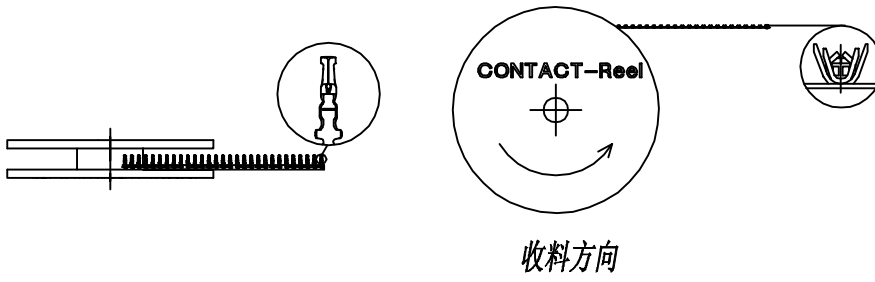

Wire Range	Insulation O.D	Material	Finish	Qty/reel
AWG#28~#32	0.90mm(max)	Phosphor Bronze	Gold-plated	15,000 pcs

LHF 东莞市连海电子有限公司
DONG GUAN LIAN HAI ELECTRONICS CO.LTD

核准 单位 比例 材质 颜色

周涛 M M 1:1 C5191 *

审核 版次 图法 未标注公差:

料号	JAE1.25-T	比例	1:1	.0 ± 0.30 .00 ± 0.20 .000 ± 0.10
品名	1.25mm pitch crimp terminal	图法	未标注公差:	
图号		日期	2013/10/05	

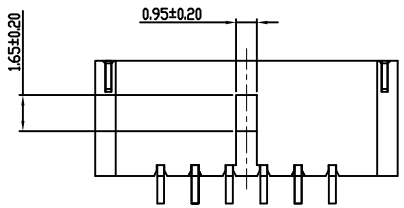
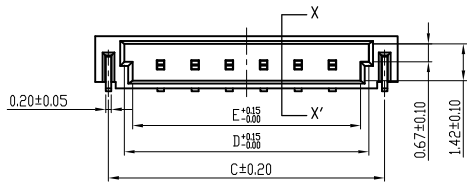
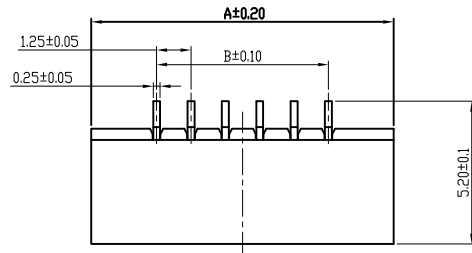

LOCKING WINDOW:ONE PLACE
2 TO 6 PIN

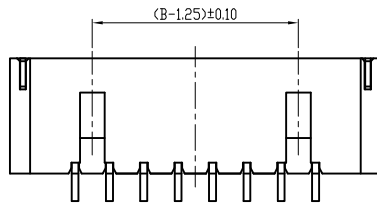
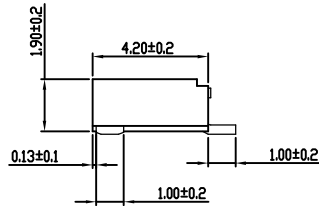
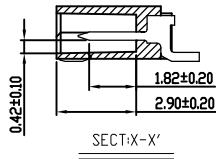

LOCKING WINDOW:TWO PLACE
MORE THAN 8 PIN

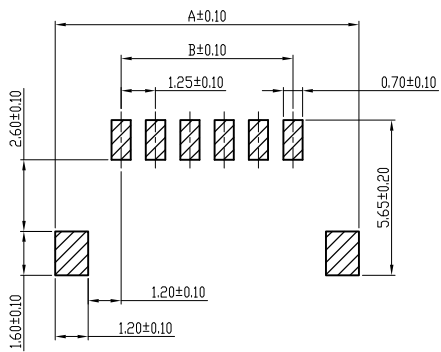

Recommended P.C.B Layout

注释:

1. 材质

主体: LCP UL94-V0
端子: C2680
定位片: C2680

2. 电镀

端子: 镀纯雾锡, 镍底
定位片: 镀纯雾锡, 镍底

3. 电气性能

工作电压: 125V AC/DC
额定电流: 1A AC/DC
工作温度: -25度 ~ +85度

14	21.00	16.25	20.05	18.90	18.30
13	19.75	15.00	18.80	17.65	17.05
12	18.50	13.75	17.55	16.40	15.80
11	16.00	12.50	16.30	15.15	14.55
10	15.00	11.25	15.05	13.90	13.30
9	14.75	10.00	13.80	12.65	12.05
8	13.50	8.75	12.55	11.40	10.80
6	11.00	6.25	10.05	8.90	8.30
5	9.75	5.00	8.80	7.65	7.05
4	8.50	3.75	7.55	6.40	5.80
3	7.25	2.50	6.30	5.15	4.55
2	6.00	1.25	5.05	3.90	3.30
Contacts No.of	A DIM.	B DIM.	C DIM.	D DIM.	E DIM.

LHF 东莞市连海电子有限公司
DONG GUAN LIAN HAI ELECTRONICS CO. LTD

公差参考表
(除非另有备注公差说明)

X.X	±0.30	X.°	±5°
X.XX	±0.20	X.X°	±3°
X.XXX	±0.10	X.XX°	±1°

产品名称: 1.25Wafer H2.0mm

核准: 周涛

产品料号: A1255-WR-S-NP

绘图: 刘丽娜

图号/版本: PD/A0

比例: 1: 1

视图:

单位: mm

页次: 1/1