

Ordering Information & Specifications

Part No	Wire Range	Insulation O.D.	Material	Finish	Qty/reel	Note
A1252-TP	AWG#26-#30	1.00mm(max)	Phosphor Bronze	Tin-plated	10,000pcs	1. Tin-plated thickness:60u"MIN
A1252-MTpe	AWG#26-#30	1.00mm(max)	Phosphor Bronze	Mist Tin	10,000pcs	2. Mist Tin thickness:60u"MIN

LHF 东莞市连海电子有限公司		DRAW NAME		TO	
DONG GUAN LIAN HAI ELECTRONICS CO. LTD		DF13 镀锡端子		/	
DATE	MODEL NO	TOL	DIM	DIM	TO
周涛	P/N NO: A1252-T	±0.15	X.X*	X.X*	±2*
刘丽娜	REV C	±0.10	X.XX*	X.XX*	±1*
	SCALE 1:1	±0.05	X.XXX*	X.XXX*	/
	UNIT: mm				
	SHEET: 1 OF 1				

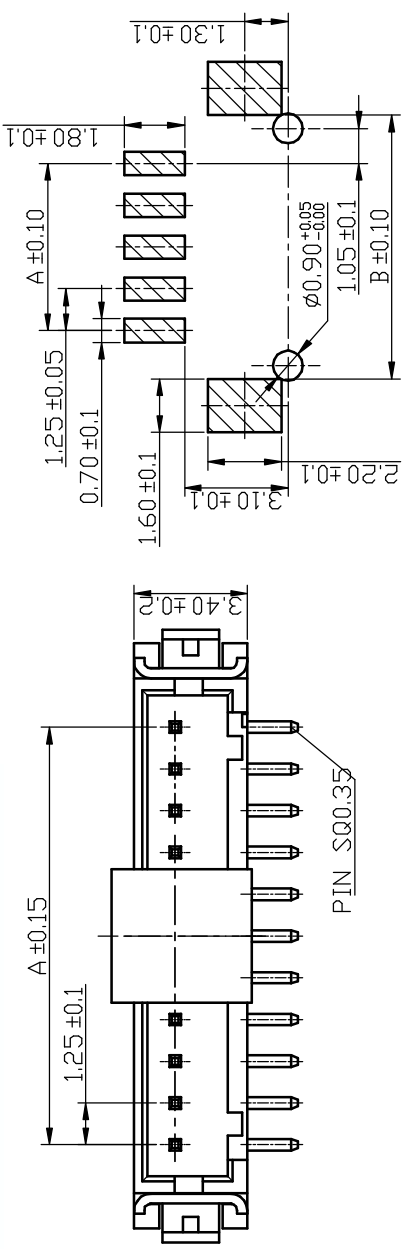

P.C.B LAYOUT

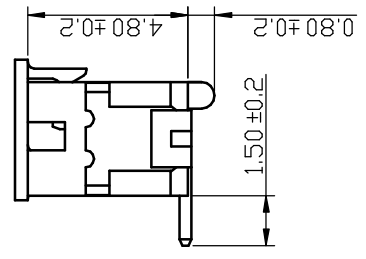
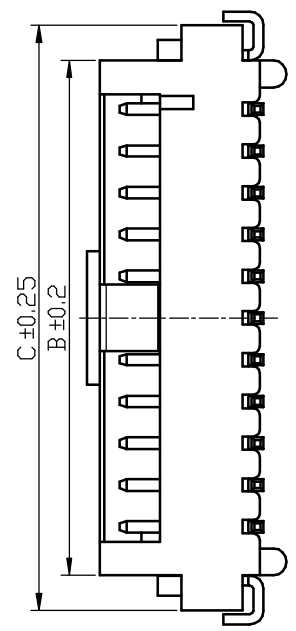

SPECIFICATIONS:
 Current Rating: 1A AC,DC
 Voltage Rating: 100V AC,DC
 Temperature Range: -25°C ~ +85°C
 Contact Resistance: 20mΩ Max.
 Insulation Resistance: 500MΩ/minute
 Withstanding Voltage: 500V AC/minute
 Pin Material: Brass/Tin-plated
 Solder Tabs: Phosphor Bronze/Tin-plated
 Material: Nylon 6T,UL94V-0

Ordering Information & Dimensions

PART NO.	Dimensions		
	A	B	C
2P	1.25	4.15	6.25
3P	2.50	5.40	7.50
4P	3.75	6.65	8.75
5P	5.00	7.90	10.00
6P	6.25	9.15	11.25
7P	7.50	10.40	12.50
8P	8.75	11.65	13.75
9P	10.00	12.90	15.00
10P	11.25	14.15	16.25
11P	12.50	15.40	17.50
12P	13.75	16.65	18.75
13P	15.00	17.90	20.00
14P	16.25	19.15	21.25
15P	17.50	20.40	22.50

A1252WV-S-F-XP

LHF DONG GUAN LIAN HAI ELECTRONICS CO. LTD		DRAW NAME DF13 立贴-NP	
MODEL NO P/N NO: A1252-WV-S-NP	DATE	SCALE 1:1	UNIT mm
DESIGN 周涛	REVISION REV C	SHEET 1/1	DFI 1
CHECK	REVIEW 刘丽娜		

DIM	TOL	DIM	TOL
X	±0.15	X*	±0.2*
XXX	±0.10	XXX*	±1*
XXXX	±0.05	XXXX*	/

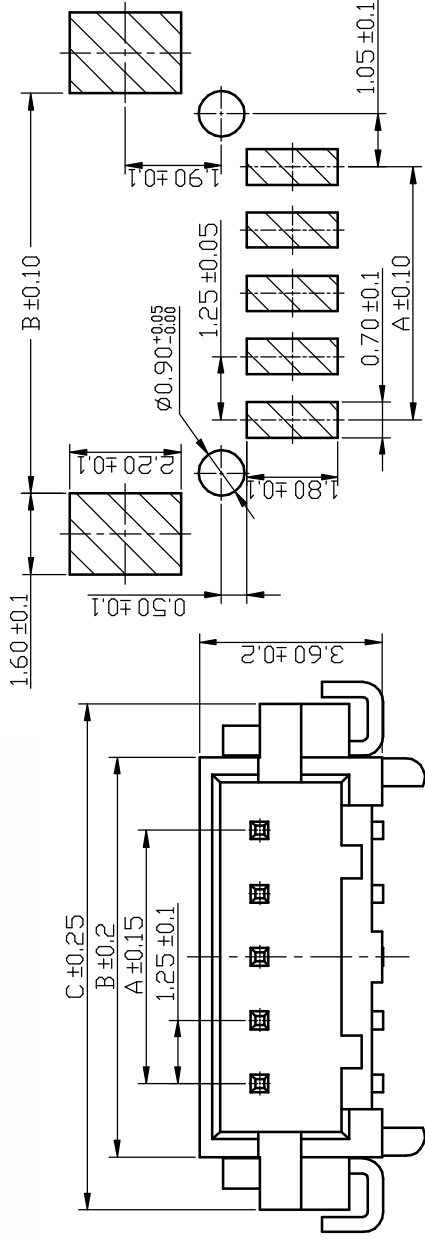

P.C.B LAYOUT

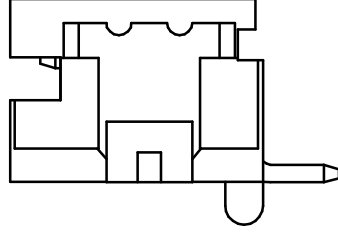
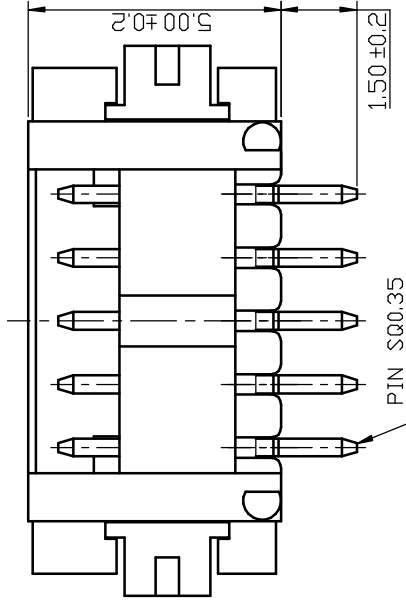

SPECIFICATIONS
 Current Rating: 1A AC,DC
 Voltage Rating: 100V AC,DC
 Temperature Range: -25°C ~ +85°C
 Contact Resistance: 20mΩ Max.
 Insulation Resistance: 500mΩ Min.
 Withstanding Voltage: 500V AC/minute
 Pin Material: Brass/Tin-plated
 Solder Tabs: Phosphor Bronze/Tin-plated
 Material: Nylon 6T,UL94V-0

Ordering Information & Dimensions

PART NO	Dimensions		
	A	B	C
2P	1.25	4.15	6.25
3P	2.50	5.40	7.50
4P	3.75	6.65	8.75
5P	5.00	7.90	10.00
6P	6.25	9.15	11.25
7P	7.50	10.40	12.50
8P	8.75	11.65	13.75
9P	10.00	12.90	15.00
10P	11.25	14.15	16.25
11P	12.50	15.40	17.50
12P	13.75	16.65	18.75
13P	15.00	17.90	20.00
14P	16.25	19.15	21.25
15P	17.50	20.40	22.50

LHF 东莞市连海电子有限公司
 DONG GUAN LIAN HAI ELECTRONICS CO. LTD

DRAW NO.	DATE	MODEL NO	DRAW NAME
DESIGN:		P/N NO:	DF13 卧贴-NP
CHECK:	周涛	A1252-WR-S-NP	
REVIEW:	刘丽娜	REV C	SCALE 1:1
		UNIT:	mm
		SHEET:	1 OF 1

DIM	TOL	DIM	TOL
X.	/	X.	/
XX	±0.15	XX	±2
XXX	±0.10	XXX	±1
XXXX	±0.05	XXXX	/

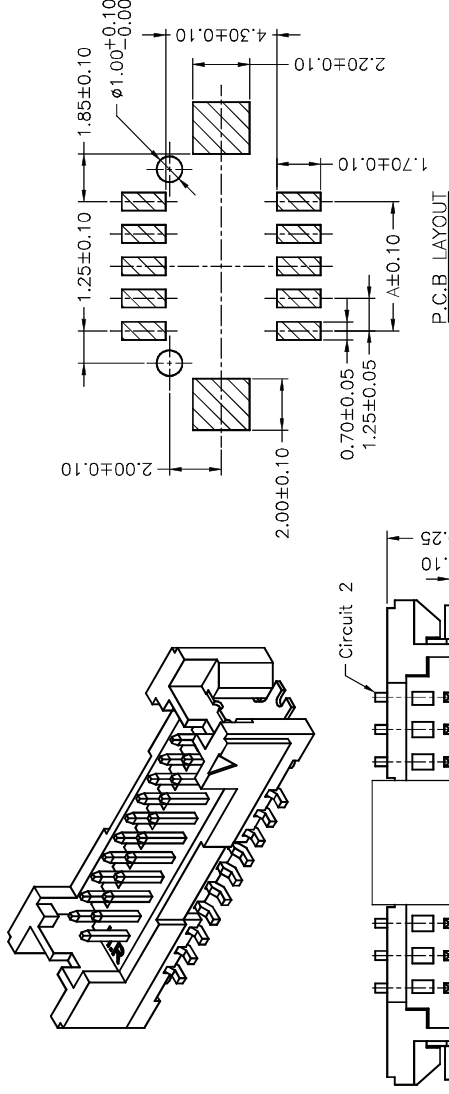

SPECIFICATIONS
 Current Rating: 1A AC,DC
 Voltage Rating: 150V AC,DC
 Temperature Range: -25°C ~ +85°C
 Contact Resistance: 30mΩ Max.
 Insulation Resistance: 500MΩ Min.
 Withstanding Voltage: 500V AC/minute
 Pin Material: Brass/Gold-flash
 Solder Tabs: Brass/Tin-plated
 Cap: Nylon 6T,UL94V-0,Natural(Beige)
 Wafer: Nylon 6T,UL94V-0
 Color: Natural(Beige)

Ordering Information & Dimensions

PART NO.	Dimensions	
	A	B
A1252-WV-S-2X5P	5.00	12.50
A1252-WV-S-2X7P	7.50	15.00
A1252-WV-S-2X10P	11.25	18.75
A1252-WV-S-2X15P	17.50	25.00
A1252-WV-S-2X20P	23.75	31.25

LHF 东莞市连海电子有限公司
 DONG GUAN LIAN HAI ELECTRONICS CO.,LTD

DATE	MODEL NO	DRAW NAME	UNIT: mm	SHEET: 1 OF 1	TO
DESIGN: 周涛	P/N NO: A1252-WV-S-2*NP	DF13 立贴-2*NP			
CHECK: 刘丽娜	REV C	SCALE 1:1			
REVIEW:					

DIM	TOL	DIM	TO
X.	/	X.	/
XX	±0.15	XX*	±1*
XXX	±0.10	XXX*	±1*
XXXX	±0.05	XXXX*	/

SPECIFICATIONS
 Current Rating: 1A AC,DC
 Voltage Rating: 100V AC,DC
 Temperature Range: -25°C ~ +85°C
 Contact Resistance: 20mΩ Max.
 Insulation Resistance: 500MΩ Min.
 Withstanding Voltage: 500V AC/minute
 Pin Material: Brass/Tin-plated
 Material: Nylon 66,UL94V-0

Ordering Information & Dimensions

PART NO.	Dimensions	
	A	B
A1252-WV-2P	1.25	3.75
A1252-WV-3P	2.50	5.00
A1252-WV-4P	3.75	6.25
A1252-WV-5P	5.00	7.50
A1252-WV-6P	6.25	8.75
A1252-WV-7P	7.50	10.00
A1252-WV-8P	8.75	11.25
A1252-WV-9P	10.00	12.50
A1252-WV-10P	11.25	13.75
A1252-WV-11P	12.50	15.00
A1252-WV-12P	13.75	16.25
A1252-WV-13P	15.00	17.50
A1252-WV-14P	16.25	18.75
A1252-WV-15P	17.50	20.00

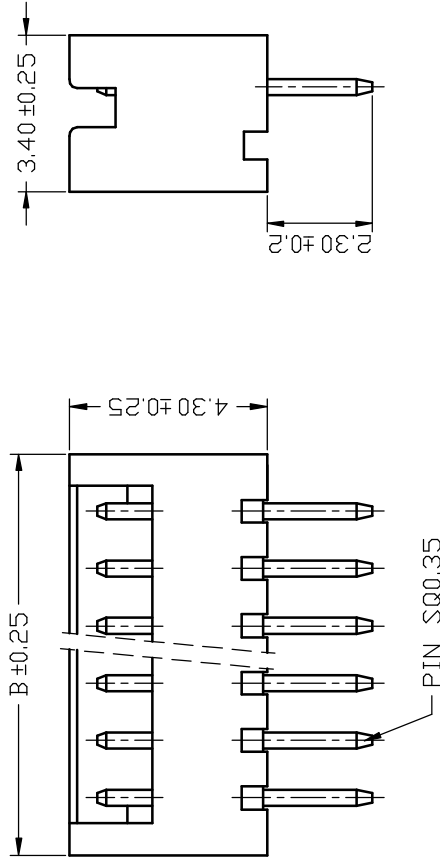
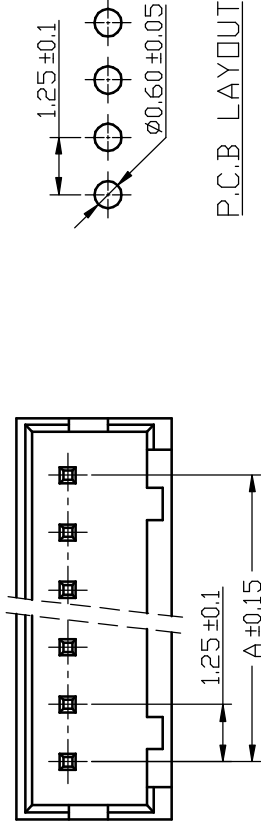

LHF		东莞市连海电子有限公司 DONG GUAN LIAN HAI ELECTRONICS CO. LTD	
DRAW NO.	DATE	MODEL NO	DRAW NAME
DESIGN:		P/N NO.	DF13 180度WF-NP
CHECK	周涛	A1252-WV-NP	
REVIEW:	刘丽娜	REV C	SCALE 1:1
		UNIT: mm	SHEET: 1 OF 1

DIM	TOL	DIM	TOL
X.	/	X.	/
XX	±0.15	XX	±0.2
XXX	±0.10	XXX	±1*
X.XXX	±0.05	X.XXX*	/

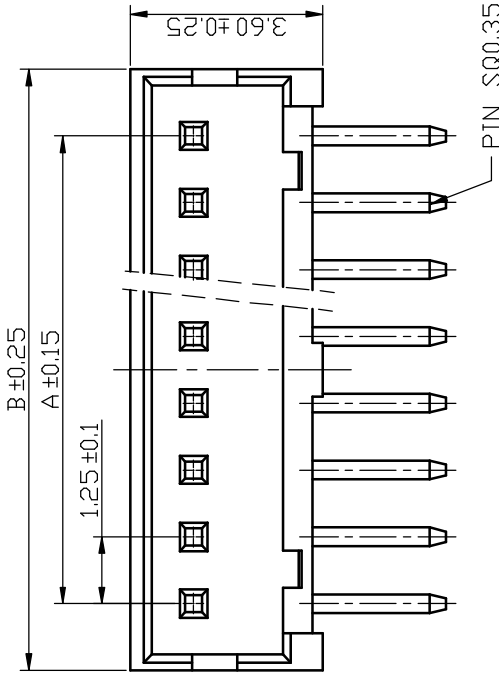

SPECIFICATIONS

Current Rating: 1A AC,DC
 Voltage Rating: 100V AC,DC
 Temperature Range: $-25^{\circ}\text{C} \sim +85^{\circ}\text{C}$
 Contact Resistance: $20\text{m}\Omega$ Max.
 Insulation Resistance: $500\text{M}\Omega$ Min.
 Withstanding Voltage: 500V AC/minute
 Pin Material: Brass/Tin-plated
 Material: Nylon 66,UL94V-0

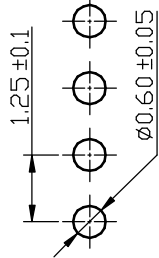

P.C.B LAYOUT

Ordering Information & Dimensions

PART NO.	Dimensions	
	A	B
A1252-WR-2P	1.25	3.75
A1252-WR-3P	2.50	5.00
A1252-WR-4P	3.75	6.25
A1252-WR-5P	5.00	7.50
A1252-WR-6P	6.25	8.75
A1252-WR-7P	7.50	10.00
A1252-WR-8P	8.75	11.25
A1252-WR-9P	10.00	12.50
A1252-WR-10P	11.25	13.75
A1252-WR-11P	12.50	15.00
A1252-WR-12P	13.75	16.25
A1252-WR-13P	15.00	17.50
A1252-WR-14P	16.25	18.75
A1252-WR-15P	17.50	20.00

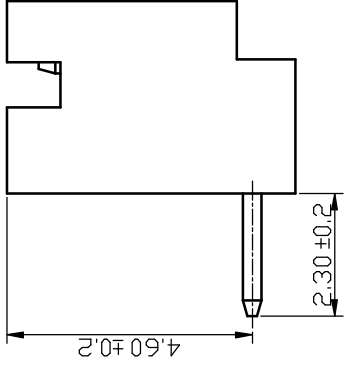
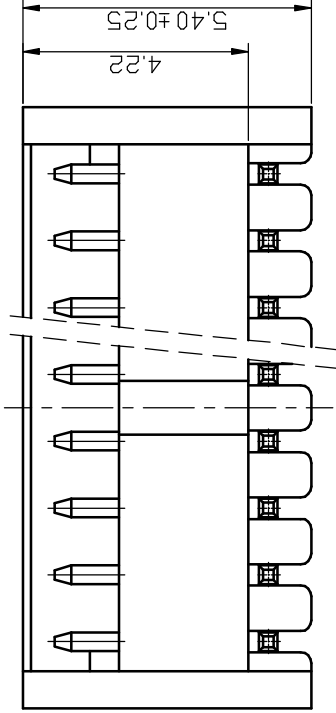

LHF 东莞市连海电子有限公司
 DONG GUAN LIAN HAI ELECTRONICS CO. LTD

DATE	MODEL NO	SCALE	UNIT	DRAW NAME
周涛	P/N NO: A1252-WV-S-2*NP	1:1	mm	DF13 立贴-2*NP
DESIGN:	REV C	1:1	1 DF1	
CHECK:				
REVIEW:	刘丽娜			

DIM	TOL	DIM	TO
X	X*	X*	/
XX	± 0.15	XX*	$\pm 2^{\circ}$
XXX	± 0.10	XXX*	$\pm 1^{\circ}$
XXXX	± 0.05	XXXX*	/

A1252WR-XP

SPECIFICATIONS
 Current Rating: 1A AC,DC
 Voltage Rating: 100V AC,DC
 Temperature Range: -25°C ~ +85°C
 Contact Resistance: 20mΩ Max.
 Insulation Resistance: 500MΩ Min.
 Withstanding Voltage: 500V AC/minute
 Material: Nylon 66,UL94V-0

Ordering Information & Dimensions

PART NO.	Dimensions	
	A	B
A1252-H-2P	1.25	4.15
A1252-H-3P	2.50	5.40
A1252-H-4P	3.75	6.65
A1252-H-5P	5.00	7.90
A1252-H-6P	6.25	9.15
A1252-H-7P	7.50	10.40
A1252-H-8P	8.75	11.65
A1252-H-9P	10.00	12.90
A1252-H-10P	11.25	14.15
A1252-H-11P	12.50	15.40
A1252-H-12P	13.75	16.65
A1252-H-13P	15.00	17.90
A1252-H-14P	16.25	19.15
A1252-H-15P	17.50	20.40

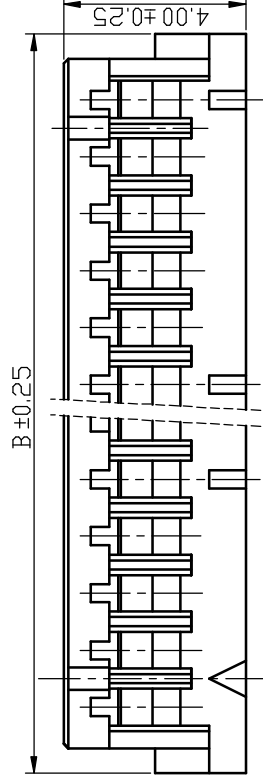
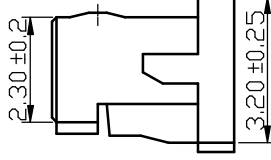
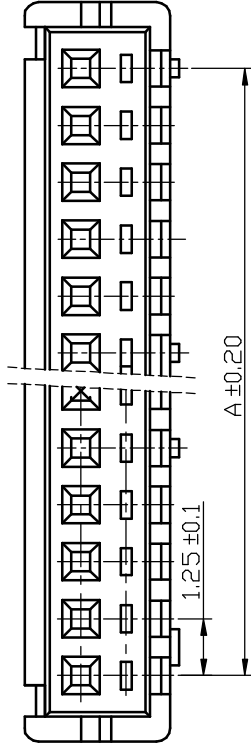

DIM	TOL	DIM	TD
X	/	X	/
XX	± 0.15	XX	± 2
XXX	± 0.10	XXX	± 1
XXXX	± 0.05	XXXX	/

LHF		东莞市连海电子有限公司		DONG GUAN LIAN HAI ELECTRONICS CO. LTD	
DATE	DESIGN	MODEL NO	SCALE	REV C	UNIT
	周涛	P/N NO: A1252-H-NP	1:1		mm
CHECK	REVIEW	DATE	SCALE	REV C	UNIT
	刘丽娜		1:1		mm
DRAW NO		DRAW NAME		SHEET	
		DFT13 HSG-NP		1 OF 1	

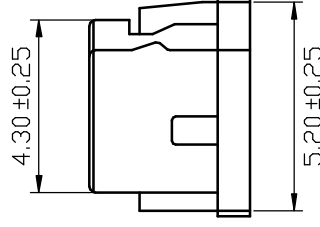
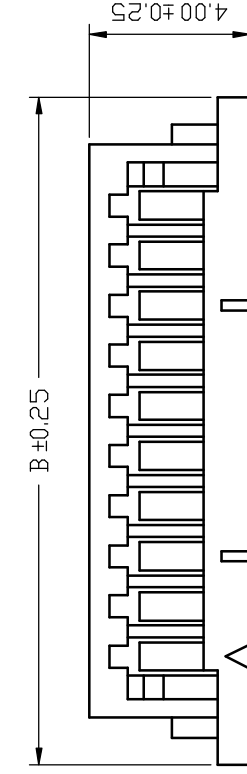
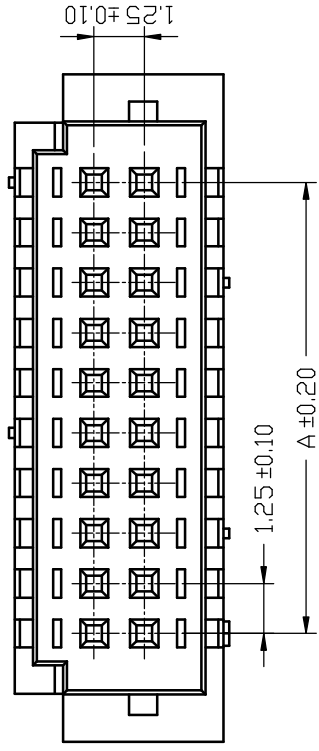

SPECIFICATIONS
 Current Rating: 1A AC,DC
 Voltage Rating: 100V AC,DC
 Temperature Range: -25°C ~ +85°C
 Contact Resistance: 20mΩ Max.
 Insulation Resistance: 500MΩ Min.
 Withstanding Voltage: 500V AC/minute
 Material: Nylon 66,UL94V-0

Ordering Information & Dimensions

PART NO.	Dimensions		PCS/BAG
	A	B	
2X5P	5.00	10.40	1,000
2X7P	7.50	12.90	1,000
2X10P	11.25	16.65	1,000
2X15P	17.50	22.90	1,000
2X20P	23.75	29.15	1,000

LHF 东莞市连海电子有限公司
 DONG GUAN LIAN HAI ELECTRONICS CO. LTD

DATE	MODEL NO	DRAW NAME	DIM	TOL	DIM	TD
周涛	P/N NO: A1252-II-2*NP	DF13 HSG-2*NP	X	X*	X*	/
CHECKY	REV C	SCALE 1:1	XX	±0.15	XX*	±2
REVIEW:	刘丽娜	UNIT: mm	XXX	±0.10	XXX*	±1*
		SHEET: 1 OF 1	XXXX	±0.05	XXXX*	/